

# EFT

## ELECTRONIC TORQUE TESTER

### TECHNICAL MANUAL

**OPERATION  
AND  
CALIBRATION  
INSTRUCTIONS**



**CDI TORQUE PRODUCTS**

# **E.T.T. OPERATING INSTRUCTIONS**

## **INTRODUCTION**

Congratulations on the purchase of one of the most accurate and user friendly electronic torque testers manufactured today. Your electronic torque tester (E.T.T.) will provide years of trouble free service with minimal maintenance. Please take a few moments and review this manual to familiarize yourself with the functions and specifications of your new tester.

If you have any questions regarding the operation or function of this tester, please call our Sales or Customer Service department for assistance at (800) 525-6319.

A complete catalog of Consolidated Devices' torque products is available upon request by phone or fax.

Thank you for your interest in CDI's torque products.

Sincerely

Consolidated Devices, Inc.

## **IMPORTANT SAFETY INSTRUCTIONS**

This manual contains important safety and operating instructions for the Electronic Torque Tester (E.T.T.). Read, understand and follow all safety messages and instructions in this manual and on the test equipment.

## **GENERAL CAUTIONS**

CDI, Inc. cannot anticipate or provide safety warnings and cautions to cover every situation that may be encountered when operating, servicing or repairing this tester. It is the responsibility of operators and servicing technicians to be knowledgeable about the procedures, tools and materials used, and to satisfy themselves that the procedure, tools and materials will not compromise their safety.

Do not attempt to operate this electronic torque tester until you have thoroughly read and completely understand all instructions and safety information in this manual. Failure to comply can result in accidents involving fire, electric shock or serious personal injury. Save this manual and review it frequently for continued safe operation, and use it to instruct others who may use this tester.

CDI, Inc. is not responsible for customer modification of test equipment for applications on which CDI, Inc. was not consulted.

**CONSOLIDATED DEVICES**  
**19920 SAN JOSE AVE.**  
**CITY OF INDUSTRY, CALIF. 91748**  
**PHONE (800) 525-6319 (626) 965-0668**  
**FAX (626) 810-2759**

# TABLE OF CONTENTS

## PAGE

E.T.T. OPERATING INSTRUCTIONS INTRODUCTION .....	1
TABLE OF CONTENTS .....	2
OPERATING INSTRUCTIONS .....	3-4
PICTURE — E.T.T.'S FUNCTION KEYS .....	5
MODES OF USE .....	6
PICTURE — MOUNTING E.T.T. TO A BRACKET .....	7
PICTURE — DIMENSIONS OF ALL MODELS OF E.T.T. ....	7
PICTURE — SUGGESTED MOUNTING POSITIONS FOR E.T.T. USE .....	8
PICTURE — CORRECT/INCORRECT HAND POSITION DURING TESTING .....	9
IMPORTANT NOTICES .....	10
E.T.T. CALIBRATION PROCEDURE .....	11
CALIBRATION CHART .....	12
PICTURE — CALIBRATION ADJUSTMENT HOLES .....	13
PICTURE — ZEROING E.T.T. BEFORE CALIBRATION .....	14
PICTURE — ADJUSTING READINGS DURING CALIBRATION .....	14

## GENERAL SAFETY

### ▲ WARNING



Improper use can cause breakage.

- Read instructions before operating.
- Follow manufacturer's instructions, safety precautions, and specifications when operating tools.

*Broken equipment can cause injury.*



Flying particles can be discharged when applying torque.

**Users and bystanders must wear safety goggles.**

*Flying particles can cause injury.*



Risk of entanglement.

- When starting power tools, check for obstacles near your hand and anticipate the reaction force by gripping the tool firmly.
- Do not wear loose clothing and jewelry while operating a power tool. Loose clothes and jewelry can be caught in moving parts.
- Keep body parts away from rotating parts.
- Wear a protective hair covering to contain long hair and prevent contact with moving parts.
- Do not overreach. Keep proper footing and balance at all times.

*Entanglement can cause injury.*

- Never attempt to test an impact tool or pulse type tool on this instrument.
- Mount the ETT securely to a heavy bench, wall or other support structure before applying torque.
- Do not use tester if it makes unusual noises, has loose parts, or shows any other sign of damage. Have repairs performed at an authorized center before use.
- Do not use chipped, cracked, or damaged sockets and accessories.
- Do not remove any labels. Replace any damaged label.

## CHARGER SAFETY

### ▲ WARNING



Risk of electric shock and fire.



- Do not allow conductive objects to come in contact with terminals. 120 or 220 volts present at charger terminals.
- For indoor use only. Do not expose charger to rain or snow. Do not use in damp locations.
- Replace defective cord immediately. Return to qualified service center for replacement.
- Do not use any other type of charger. Using a charger not specifically designed for this unit may cause the battery to burst, releasing caustic chemicals.
- Do not use an extension cord with charger.
- Do not use a damaged charger.
- Do not disassemble charger.
- Do not attempt to connect two chargers together.
- Do not operate charger with damaged cord or plug. Replace immediately.
- Do not operate charger after it is dropped, receives a sharp blow or is damaged. Take the charger to an Authorized Service Center.
- Unplug charger from outlet before maintenance or cleaning. Turning off controls is not adequate to avoid hazard.
- Read all instructions and safety messages on battery and battery charger before use.

*Electric shock or fire can cause injury.*

**SAVE THESE INSTRUCTIONS**

## TORQUE TESTER SAFETY

### ▲ WARNING

- Be sure ratings for all components, including, adaptors, extensions, drivers and sockets, match or exceed the torque being applied.
- Do not use this instrument with power off. Always turn on power to meter so torque values display.
- Be sure the capacity of the ETT matches or exceeds each application before performing a procedure.
- Pull on a wrench handle—do not push—and adjust stance to prevent a possible fall.
- Do not use extension, such as a pipe, on a wrench handle.
- Fully engage the direction lever in the correct position when using ratchets.

# E.T.T. OPERATING INSTRUCTIONS

## TESTER SET UP PROCEDURE:

- A. The shipping/carrying container should contain the following items:
  1. Electronic Torque Tester (E.T.T.)
  2. 110 Volt A.C. Adapter recharging unit
  3. Female to female socket adapter
  4. E.T.T. Operating instructions
  5. Certificate of Accuracy traceable to N.I.S.T. (National Institute of Standards Technology)
- B. Remove the E.T.T. from the container and place the tester on a bench or table. Plug the male adapter recharging unit into the female receptacle on the battery cover (bottom black cap of tester) and the other end into a 110 volt wall outlet. Allow approximately 24 hours for a full charge of NiCad batteries before heavy use. **Note:** leaving the recharging unit attached to the tester and charging the NiCad batteries continuously is acceptable and desired if the tester is not needed for portable use.
- C. Turn the tester “on” via the “rocker” switch on the top of the tester. The display should show four zeros (0000). If not, turn the “zero adjust” knob on the side of the tester so that the four digits are as close to all zeros as possible. The zero adjust knob is quite sensitive, therefore, slow turns are recommended.
- D. Place the appropriate female to female socket adapter, (one provided with each tester), on the male square drive of the tester (see page 4 for listings of additional sockets available).
- E. Select the torque “mode” of operation desired. There is a “mode” selection switch on the right side of the tester. Select between “track”, “peak hold”, “first peak” or “power tool” operational modes. (See page 6 for description of types of tools and their specific modes of use.)
- F. Select the torque engineering units desired. There is a dual scale clearly marked in the center of all E.T.T. models (English and NM scales are standard).
- G. Select one of the options for clearing the display; either manually or automatically. If MANUAL CLEARING is desired, the display will hold the reading on the LCD until the “R” reset button is pressed. If you wish to cycle a torque wrench and wish to not press the reset key repeatedly, then select the AUTO RESET function. The torque value shown on the display will “hold” for approximately two (2) seconds and then clear to all zeros.
- H. Adjust the swivel head to a position that facilitates reading the LCD. E.T.T. is the only tester in our industry that allows an operator to view the display from any position by rotating the head of the tester for easy viewing.

## SPECIFICATIONS

### Display

LCD on swivel neck  
0.43" characters

### Display Capacity

4 digits, 9,999 counts

### Accuracy

± 0.5% of reading ± 1 count in the least significant digit (10–100% of full range)  
@ 25°C

### Stability

+ 0.044% per °C

### Units of Measurement

Refer to model information

### Front Panel Controls (Pushbuttons)

- Display Units
  - English
  - Metric

### • Mode Selector

- MANUAL
- AUTO

### • Reset

### Side Panel Controls

- Zero adjust
  - ± 5% of full range tare
- Mode Selector
  - TRACK
  - PEAK HOLD
  - FIRST PEAK
  - POWER TOOL

### Operating Temperature

5–42°C (40–110°F)

### Storage

–20–50°C (–2–122°F)

### Humidity

Up to 90%, non-condensing

### Dimensions

Width...4.5"  
Height...14.6"  
Depth...2.5"

### Weight

4.5 lbs.  
5.0 lbs. 6004-F-ETT

### Battery

Two 9V Nickel cadmium, replaceable

### Charge Life

8 hours continuous, full charge to LOW BATTERY flag

### Battery Charger

Input...120VAC or 220VAC (50-60 Hz)  
Output...9VDC, 200 ma

### Integral Transducer

Full bridge strain gage, 350 ohms,  
1500 µE, 3mV/V F.S., 3.75V excitation

# MOUNTING CONSIDERATIONS

Mounting the E.T.T. tester for use is very important. A mounting bracket is available from CDI (part number TBM 343 – see page 5) for mounting to a sturdy table or portable cart. E.T.T. can also be mounted to a wall, column or post. Please mount tester securely to any of the above surfaces with 1/4" bolts, nuts and washers (see page 7 for typical mounting).

## NOTE:

When mounting your E.T.T., allow adequate working room for the torque tools being checked. If mounting to a work bench, roller cabinet, etc. consider the amount of torque being applied and the weight / support needed to counter-balance the applied torque (see page 8 for suggested mounting options).

\*\*\*\*\*

## USE OF POWER TOOLS -- OPTIONAL EQUIPMENT: JOINT RATE SIMULATOR

When testing power tools, it is recommended that a joint simulator be used between the power tool and the tester. CDI offers several different models with specific torque range capacities. Each has the ability to simulate a hard, medium or soft joint rate condition.

PART #	CAPACITY	DRIVE SIZE
900-0	50" lb. maximum	1/4" female drive
900-2-0	400" lb. maximum	3/8" female drive
900-3-0	1000" lb. maximum	1/2" female drive

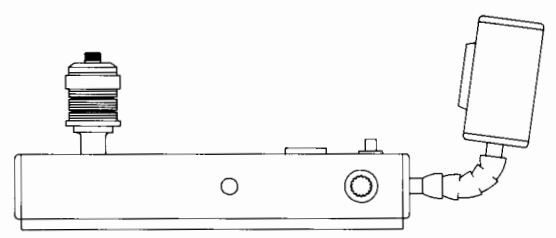

- 900-0 Supplied with a 3/16" hex driving bit x 1/4" hex
- 900-2-0 Supplied with a 3/8" hex driving bit x 3/8" female socket
- 900-3-0 Supplied with a 1/2" hex driving bit x 3/8" female socket

\*\*\*\*\*

## FEMALE TO FEMALE SOCKET ADAPTERS AVAILABLE -- OPTIONAL EQUIPMENT:

\*\* EACH E.T.T. TESTER IS SUPPLIED WITH A FEMALE TO FEMALE SOCKET ADAPTER THAT IS SIZED FOR EACH PARTICULAR TESTER. EXAMPLE: A 2502-I-ETT WOULD BE SUPPLIED WITH A 3/8" X 3/8" ADAPTER IN THE SHIPPING CONTAINER BECAUSE THE SQUARE DRIVE OF THE TESTER IS A MALE 3/8" SQUARE DRIVE.

Part Number	Opening	x	Opening
260-27	1/4" hex	x	1/4" sq.
260-28	1/4" hex	x	3/8" sq.
342-40	1/4" sq.	x	1/4" sq.
342-41-1	1/4" sq.	x	3/8" sq.
342-41-2	3/8" sq.	x	3/8" sq.
65-26-1	1/2" sq.	x	1/4" sq.
65-26-2	1/2" sq.	x	3/8" sq.
65-26-3	1/2" sq.	x	1/2" sq.
65-78-1	1/2" sq.	x	3/4" sq.
65-78-2	3/4" sq.	x	3/4" sq.
75-25-2	1" sq.	x	1/2" sq.
75-25-1	1" sq.	x	3/4" sq.

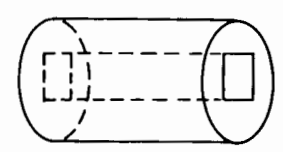

# E.T.T.

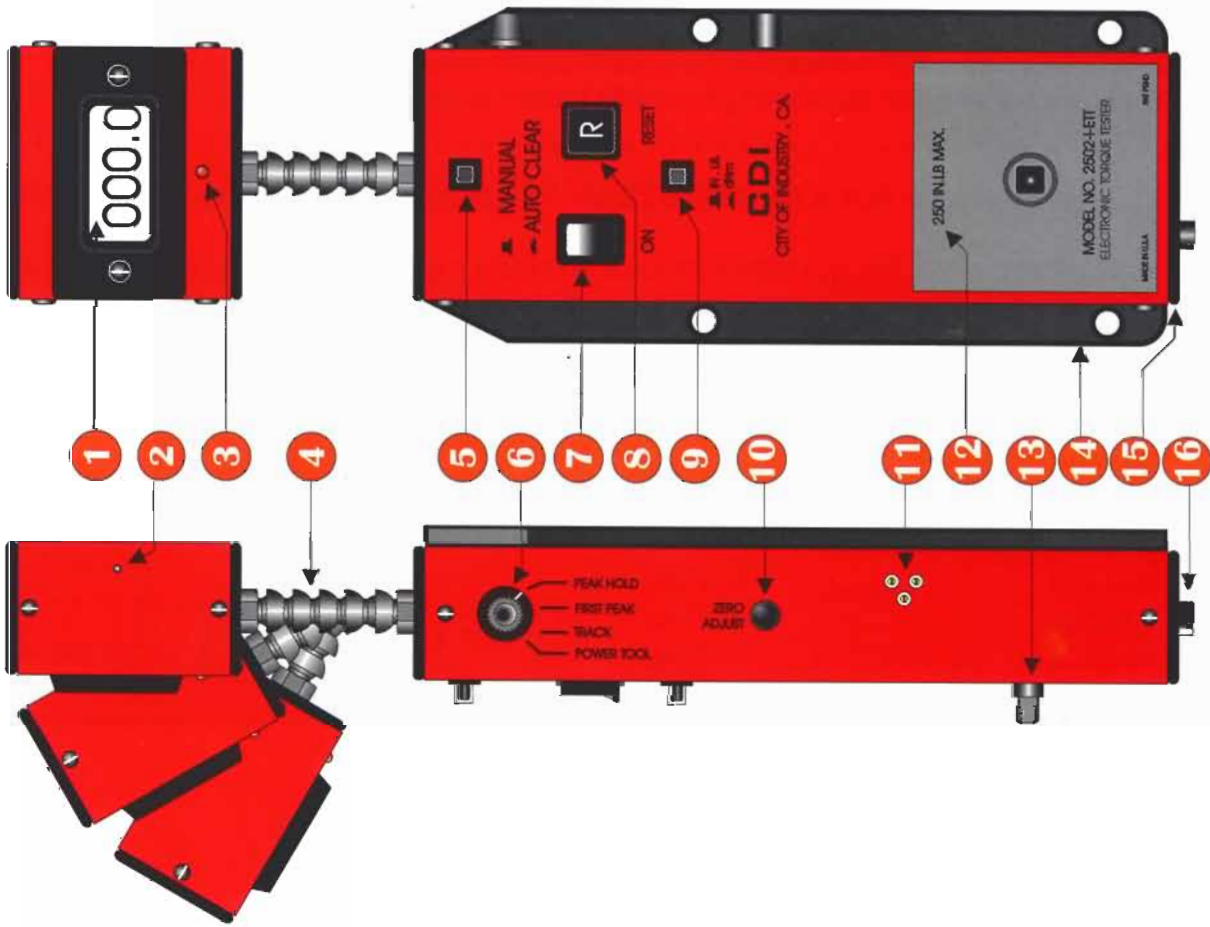

- 1 **LCD Display** - 4 1/2 active digits shows torque values being applied.
- 2 **Audio Hole** - a "beep" sounds indicating E.T.T.'s electronics has captured a "first peak" value.
- 3 **LED Indicator** - a light flashes when a "first peak" is captured.
- 4 **Swivel Neck** - allows for orienting E.T.T.'s head into desired viewing position.
- 5 **Manual / Auto-Clear Button** - allows (2) options of clearing torque values from LCD.
- 6 **Mode Selection Switch** - a four position rotary switch allows (4) choice selections of operational torque modes ( track, peak hold, first peak and power tool ).
- 7 **On-Off Rocker Switch** - turns on / off E.T.T. tester.
- 8 **Reset Button** - clears the LCD while in the manual clear mode.
- 9 **Torque Units Button** - allows for a choice of (2) different torque engineering units.
- 10 **Zero Adjust Button** - allows an operator to manually "zero" the LCD digits.
- 11 **Calibration Screws** - for making adjustments during the calibration procedure.
- 12 **Torque Range Indicator** - shows the maximum allowable torque for this tester.
- 13 **Male Square Drive** - the physical connection to E.T.T.'s transducer.
- 14 **Backplate** - sturdy pre-drilled support backplate used for mounting E.T.T. to a table, wall, bench or rolling cart.
- 15 **Battery Cover Plate** - a cover plate for access to the rechargeable NiCad batteries.
- 16 **A.C Adapter Plug** - for attaching the supplied A.C power cord to E.T.T. for recharging the NiCad batteries.

FIG 1.0

**MODES OF USE:**

Refer to opposite page for location of Mode Selector Switch.

- **Track Mode** -- Used mainly for calibration of the torque tester. The display “tracks” the number up when a force is applied. At the moment the force is released, the displayed number “tracks” down. The unit will not “hold” any torque value on the display.
- **Peak Hold Mode** -- Used mainly for dial and beam type wrenches. As the force is applied, the tester will “hold” the highest value applied to the tester.
- **First Peak** -- Used mainly for micrometer (click) type torque wrenches. E.T.T. electronically captures the torque value at the moment of the “camming” over or “click” of the wrench. A red light (LED) flashes and an audible tone sounds at this time.
- **Power Tool Mode** – Used primarily with non-impact type of air or electric tools. A joint simulator is recommended for simulating rotational “run down” conditions as well as joint rate conditions (hard, medium or soft). “Pulse” type air tools should be tested for accuracy/repeatability for each tool manufacturer and each specific model tool. Pulse type air tools are not generally recommended for use with E.T.T.

**TORQUE TOOLS AND THEIR RECOMMENDED “MODE” USE:**

- Dial Wrenches and Screwdrivers - Peak (or Track) Mode
- Beam Wrenches - Peak (or Track) Mode
- Micrometer Wrenches - First Peak Mode
- Pre-set Wrenches - First Peak Mode
- Power Tools - Air and Electric - Power Tool or Peak Modes
- Calibration - Track Mode

\*\*\*\*\*

**MODELS OF E.T.T. AVAILABLE**

Please consider any of the various E.T.T. torque tester models CDI offers:

<u>Part #</u>	<u>Primary Range / English</u>	<u>Secondary Range / Metric</u>	<u>Size</u>	<u>Weight</u>
1001-O-ETT	10-100 In. ozs.	7.0-70.6 cNM	1/4"	4.5 lbs.
2001-O-ETT	10-200 In. ozs.	7.0-141 cNM	1/4"	4.5 lbs.
4001-O-ETT	40-400 In. ozs.	28-282 cNM	1/4"	4.5 lbs.
501-I-ETT	5-50 In. lbs.	5.65-56.5 dNM	1/4"	4.5 lbs.
1001-I-ETT	10-100 In. lbs.	11.3-113 dNM	1/4"	4.5 lbs.
2502-I-ETT	25-250 In. lbs.	28.3-283 dNM	3/8"	4.5 lbs.
10002-I-ETT	100-1000 In. lbs.	113-1130 dNM	3/8"	4.5 lbs.
2503-F-ETT	25-250 Ft. lbs.	33.9-339 NM	1/2"	4.5 lbs.
6004-F-ETT	60-600 Ft. lbs.	81.4-814 NM	3/4"	5.0 lbs.

All models use the same recharging adapter power cord – CDI part number P115-30 (supplied)

# E.T.T. DIMENSIONS

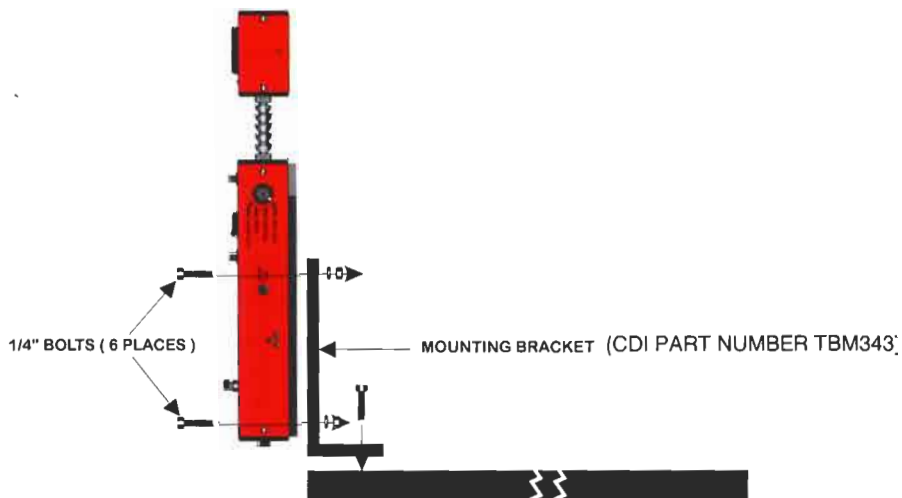
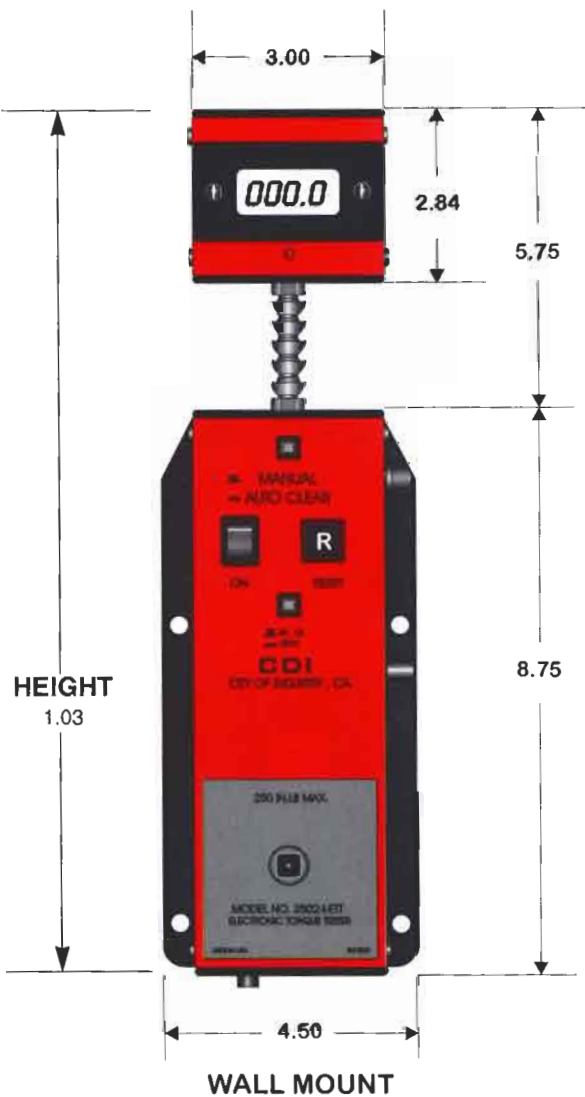
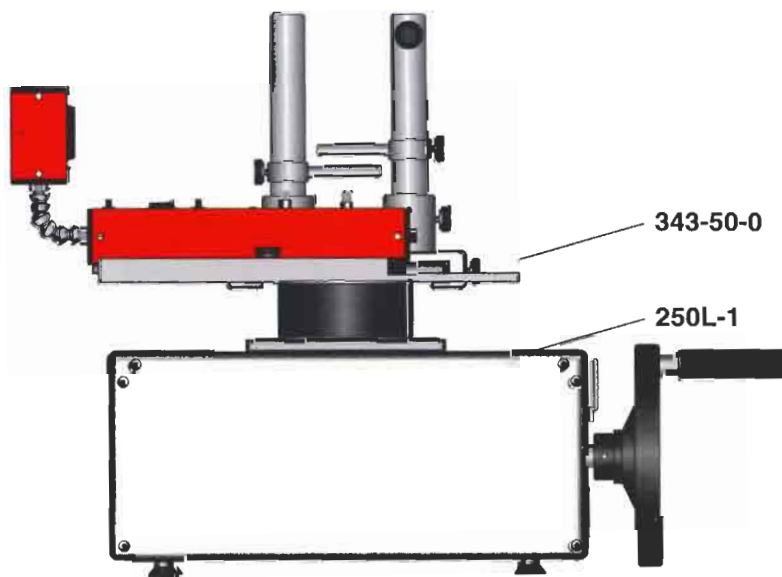

FIG.1.1  
MOUNTING E.T.T. TO BRACKET



E.T.T. SHOWN ON CDI'S MECHANICAL LOADER 250L-1  
BRACKET CONNECTING E.T.T. TO LOADER 343-50-0



# SUGGESTED WAYS TO MOUNT E.T.T.

FIG. 1.4

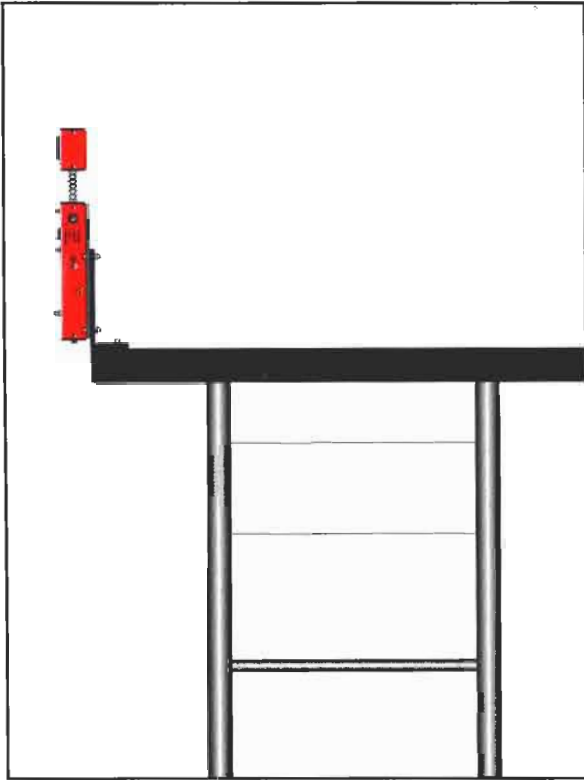

TO A STURDY TABLE

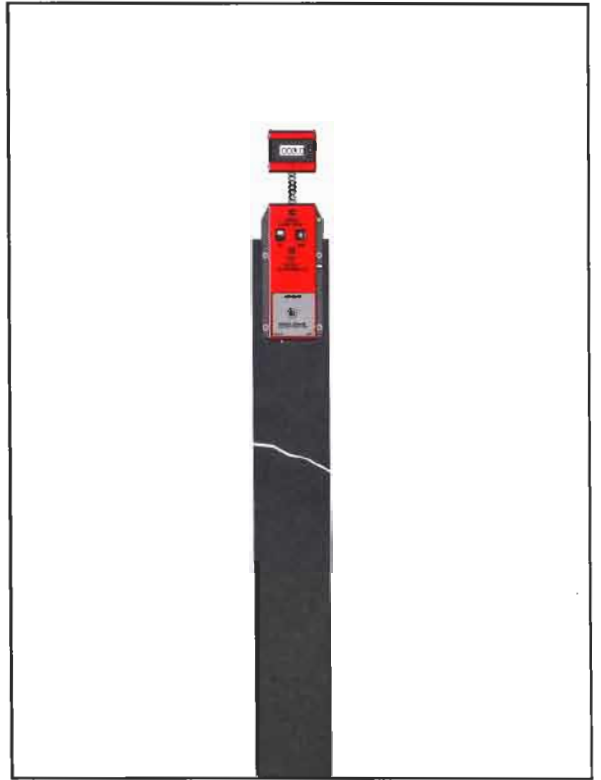

TO A STEEL POST OR "I" BEAM

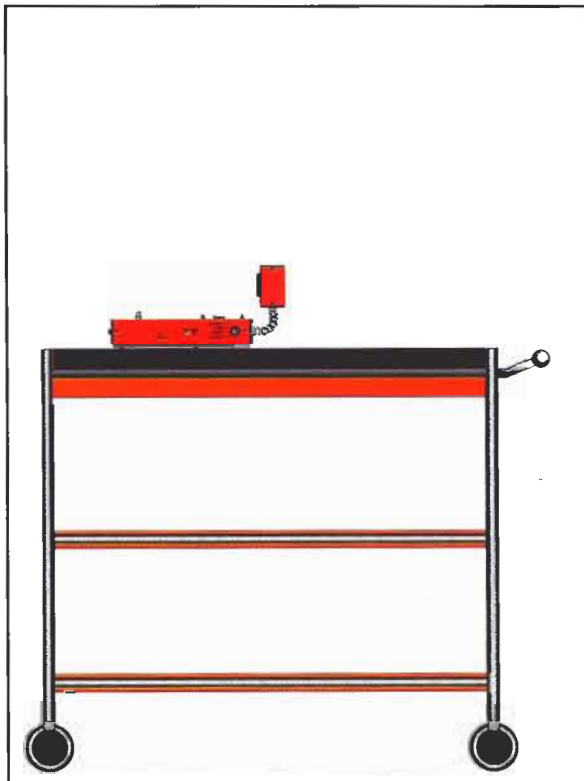

TO A PORTABLE CART FOR ONLINE TESTING

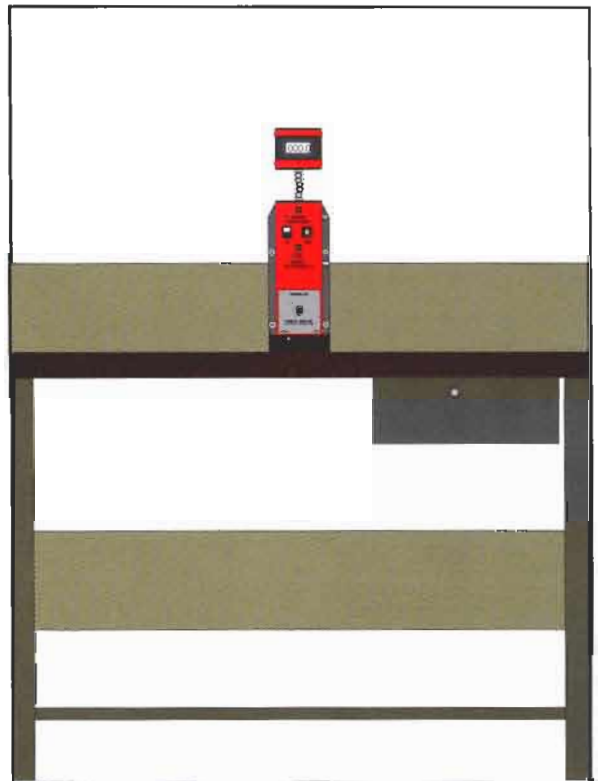

TO A STURDY WORKBENCH

FIG. 1.2

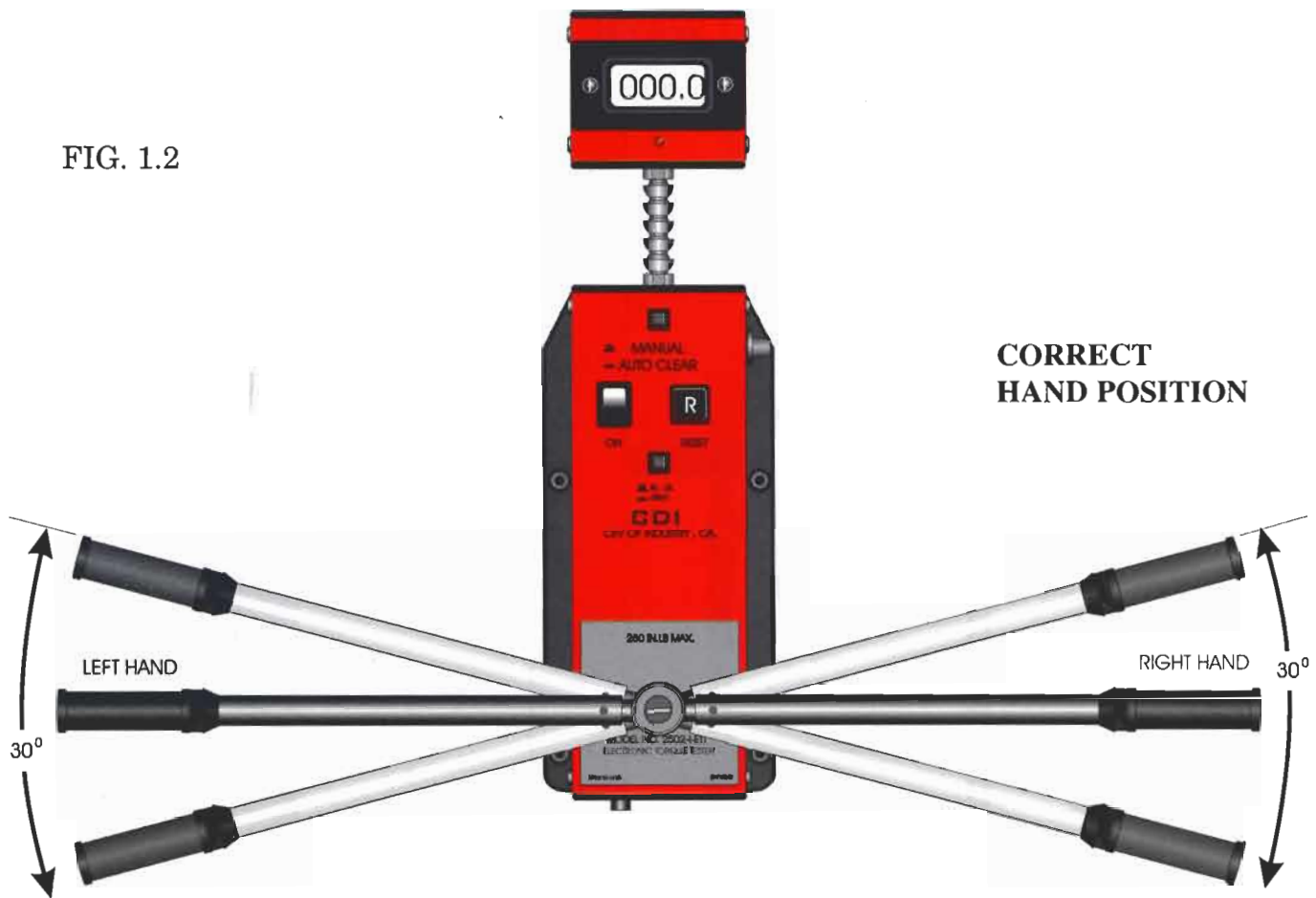
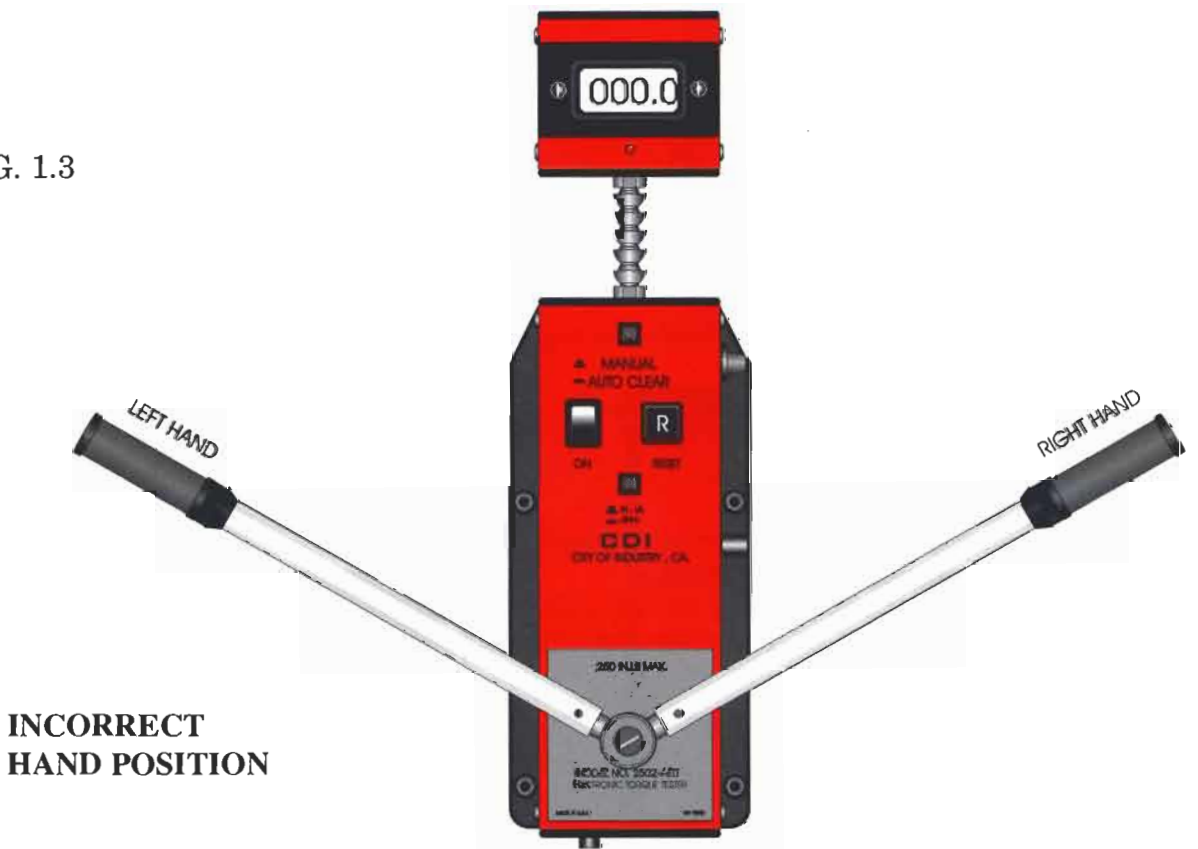

FIG. 1.3



# IMPORTANT NOTICES

PLEASE READ THE FOLLOWING CAUTIONS AND WARNINGS BEFORE USING YOUR E.T.T. (ELECTRONIC TORQUE TESTER).

THE ELECTRONIC TORQUE TESTER (E.T.T.) IS A TRANSDUCER. TORQUE TRANSDUCERS ARE SENSITIVE MEASURING INSTRUMENTS. "OVER-TORQUING" PAST THE USEABLE RANGE OF THE TRANSDUCER MAY RESULT IN PERMANENT DAMAGE TO THE TRANSDUCER. ALWAYS LOAD THE TRANSDUCER SLOWLY AND DO NOT EXCEED THE USEABLE RANGE IN ANY APPLICATION.

PRIOR TO USING YOUR E.T.T. FOR ANY APPLICATION, IT MUST BE "EXERCISED" TO THE MAXIMUM RANGE BEING USED (REFER TO PAGE 9 FOR PROPER TORQUE WRENCH USE WITH E.T.T.) PRIOR TO TAKING READINGS. TO ACCOMPLISH THIS, TAKE THE WRENCH BEING TESTED, APPLY THE HIGHEST INDICATED VALUE OF THIS WRENCH. THEN LET THE WRENCH AND THE TRANSDUCER RETURN TO A "NO-LOAD" POSITION. REPEAT THIS PROCEDURE TWO MORE TIMES. REMOVE WRENCH FROM TESTER AND TURN THE "ZERO" BUTTON ON THE SIDE OF E.T.T. SO THE LCD READS ALL ZEROS.

WHEN THE DIRECTION (CLOCKWISE OR COUNTER-CLOCKWISE) IS CHANGED, THE TRANSDUCER MUST BE EXERCISED IN THE NEW DIRECTION OF USE, AS EXPLAINED ABOVE, BEFORE TAKING READINGS.

## WARNING

DO NOT USE ANY TYPE OF IMPACT OR "PULSE" TYPE POWER TOOL ON THE E.T.T. TESTER. STALL AND CLUTCH-TYPES OF AIR OR ELECTRIC ASSEMBLY TOOLS CAN BE USED AS LONG AS THE MAXIMUM RANGE OF THE TRANSDUCER IS NOT EXCEEDED. A TRANSDUCER DAMAGED DUE TO APPLICATION OF AN IMPACT TOOL WILL NOT BE COVERED UNDER WARRANTY.

## WARRANTY

ELECTRONIC TORQUE TESTERS ARE WARRANTED AGAINST DEFECTS IN MATERIAL AND WORKMANSHIP FOR A PERIOD OF ONE YEAR FROM THE DATE OF PURCHASE. CDI, OR OUR AUTHORIZED REPRESENTATIVE WILL, AT OUR OPTION, REPAIR OR REPLACE ANY DEFECTIVE E.T.T. MANUFACTURED BY CDI. THE TESTER MUST BE RETURNED TO CDI OR OUR AUTHORIZED REPAIR STATION POSTAGE PRE-PAID.

THE FOREGOING OBLIGATION IS CDI'S SOLE LIABILITY AND THE PURCHASER'S SOLE REMEDY UNDER THIS WARRANTY. THERE ARE NO OTHER WARRANTIES EXPRESSED OR IMPLIED, INCLUDING THOSE OF MARKETABILITY OR FITNESS FOR PURPOSE. UNDER NO CIRCUMSTANCES SHALL CDI BE LIABLE FOR ANY SPECIAL INCIDENTAL OR CONSEQUENTIAL DAMAGE.

























THIS WARRANTY DOES NOT APPLY IF THE E.T.T. HAS BEEN ALTERED, DAMAGED, ABUSED OR IMPROPERLY MAINTAINED. THIS WARRANTY GIVES YOU SPECIFIC LEGAL RIGHTS AND YOU MAY HAVE OTHER RIGHTS WHICH VARY FROM STATE TO STATE.

# E.T.T. CALIBRATION PROCEDURE

(SEE CALIBRATION CHART – PAGE 12)

*\*\*\*All E.T.T.'s are certified accurate to +/- .5% ± 1 increment in the least significant digit of indicated value bi-directionally.*

- 1.) Mount E.T.T. in a vertical position with a sturdy mounting bracket from the edge of a table (see page 14 fig. 1.6) so that the weights and calibration arms will not be obstructed. Anchor the unit securely to a firm table, bench, etc. Consider the amount of weights used and force applied when selecting the working area. Note: Plug in charging adapter to 110 volt outlet.
- 2.) **Turn the power “on” and SET THE TESTER IN “AUTO CLEAR” MODE (button just under the neck of E.T.T.) and in “TRACK” mode (on the right side of the tester).**
- 3.) Check to see if the tester is in the proper torque engineering units (i.e. in lbs./dNm).
- 4.) Install the proper arm or wheel needed for calibration (see calibration chart-page 12).
- 5.) Zero the display using the “zero” knob on the right side of E.T.T. (see fig. 1.6).
- 6.) Pre-load the transducer to full scale three times in the left hand (c.c.w.) direction. Note: use only certified arms, weights and weight trays. Example: a 2502-I-ETT requires 25 lbs. of weight to pre-load the transducer to its maximum. Add and remove weights three times in the left hand direction. This procedure exercises the transducer. Do not be concerned about the readings at this time. Remove all weights and weight trays. (Leave the arm or wheel on E.T.T.)
- 7.) After all the weights have been removed, once again “zero” the display-step #4. You are now ready to “check” E.T.T. for it’s accuracy.
- 8.) Apply the necessary weights to reach 50% of the torque range of the transducer. Example: 2502-I-ETT requires 12.5 lbs. of weight to reach 125 in. lbs. of reading (this is 1/2 of the total range of the tester). The display should read +/- .5% ± 1 increment of 125 in. lbs. or within the span 124.3 – 125.7.
- 9.) If the readings need to be adjusted, use the following procedure with the weights still hanging (see pg. 14 fig. 1.7): On the right hand side of the tester (as you are facing the unit), there are three holes through the housing of the E.T.T. (see fig 1.5 for reference). Sometimes these holes are covered by a “VOID IF BROKEN” sticker that will have to be removed. The top hole (see pg. 13) is the access to a potentiometer screw that adjusts the left hand (c.c.w.) direction torque value displayed on the LCD. The middle hole potentiometer screw adjusts the right hand (c.w.) direction. All adjustments can be made with a straight blade screwdriver small enough to fit in the adjusting hole. Turn the top of the potentiometer screw to the left or right until the targeted torque value appears on the LCD (in the example – 125.0).
- 10.) The secondary torque units, NM/dNM/cNM, are to be checked at this time. Since the weights are still hanging from the adjustments (or check) just made above, press the “dual scale” button (English/NM button in the center of the tester) putting E.T.T. into it’s alternate scale. Being sure you are referencing the values in NM, dNM or cNM, turn the potentiometer screw in the left button hole left or right to reflect the correct value in the secondary NM scale.
- 11.) Remove all the weights and re-zero if necessary. Push “units” button before calibrating, making sure you are in English units. Add weights needed to check the unit at 10%, 50% and 100% of full value in both scales (see page 12). If the readings are out of calibration at any point, adjust the readings as needed to bring E.T.T. into the .5% ± 1 increment acceptable tolerance allowed. **VERY IMPORTANT — Recheck all readings after making any adjustments**
- 12.) Repeat the above steps to calibrate E.T.T. in the right hand (c.w.) direction.
  - A. Remember to exercise the unit three times before starting the calibration procedure in the new direction.
  - B. Remember the middle hole potentiometer screw is for adjustments in the right hand (clockwise) direction (see fig 1.5 for reference).

TRANSDUCER CALIBRATION CHART ETT										07-02-96								
RANGE	TESTER PART #	SUGGESTED CALIBRATION POINT	ARM TYPE & LENGTH	HANGER WEIGHT & TYPE				WEIGHT, TYPE & NUMBER OF WEIGHTS				TOTAL WEIGHT (lb)	CALIBRATION CHECK POINTS	TOTAL # OF WEIGHTS (PCS.)				
				1/4	1/2	15	50	1/4	1/2	1	2				5	10	20	50
10-100 IN.OZ.	1001-0-ETT	10 IN.OZ.	2.5" 	1				1/4	1/2	1	2	5	10	20	50	.25	10 IN.OZ.	1/4 LB.-1 1/2 LB.-2 1 LB.-2
10-100 IN.OZ.		50 IN.OZ.						2								1.25	50 IN.OZ.	
10-100 IN.OZ.		100 IN.OZ.						1	2							2.5	100 IN.OZ.	
10-100 IN.OZ.		40 IN.OZ.						1								1	40 IN.OZ.	
40-400 IN.OZ.	4001-0-ETT	200 IN.OZ.	2.5" 	1				1	2							5	200 IN.OZ.	1/2 LB.-1 2 LB.-2 5 LB.-1
40-400 IN.OZ.		400 IN.OZ.						1								10	400 IN.OZ.	
40-400 IN.OZ.		5 IN.LB.						1								1	5 IN.LB.	
5-50 IN.LB.	501-I-ETT	25 IN.LB.	5" 	1				1	2							5	25 IN.LB.	1/2 LB.-1 2 LB.-2 5 LB.-1
5-50 IN.LB.		50 IN.LB.						1								10	50 IN.LB.	
5-100 IN.LB.	1001 I-ETT	10 IN.LB.	5" 	1				1								2	10 IN.LB.	1/2 LB.-1 2 LB.-2 5 LB.-3
5-100 IN.LB.		50 IN.LB.						1								10	50 IN.LB.	
10-100 IN.LB.		100 IN.LB.						1	2	3						20	100 IN.LB.	
10-100 IN.LB.		25 IN.LB.						1		1						2.5	25 IN.LB.	
25-250 IN.LB.	2502-I-ETT	125 IN.LB.	10" 	1					1	2						12.5	125 IN.LB.	1/2 LB.-1 2 LB.-2 5 LB.-4
25-250 IN.LB.		250 IN.LB.						1		2	4					25	250 IN.LB.	
25-250 IN.LB.		150 IN.LB.														15	150 IN.LB.	
100-1000 IN.LB.	10002-I-ETT	500 IN.LB.	10" 		1							1	1	1		50	500 IN.LB.	5 LB.-1 10 LB.-2 20 LB.-3
100-1000 IN.LB.		1000 IN.LB.										1	2	3		100	1000 IN.LB.	
100-1000 IN.LB.		25 FT.LB.										1	1			30	25 FT.LB.	
25-250 FT.LB.	2503-F-ETT	125 FT.LB.	10" 		1							1	1	2		150	125 FT.LB.	5 LB.-1 10 LB.-1 20 LB.-4 50 LB.-4
25-250 FT.LB.		250 FT.LB.										1	4	4		300	250 FT.LB.	
25-250 FT.LB.		60 FT.LB.										1	1			18	60 FT.LB.	1 LB.-1 2 LB.-1 5 LB.-1 10 LB.-1 20 LB.-3 50 LB.-2
60-600 FT.LB.	6004-F-ETT	300 FT.LB.	40" 		1							1	1	3		90	300 FT.LB.	
60-600 FT.LB.		600 FT.LB.										1		3	2	180	600 FT.LB.	

**PLEASE NOTE:**

Remove the “WARRANTY VOID IF BROKEN” sticker on the right side of tester to access the calibration adjustment holes. Replace with your own sticker after calibration is completed

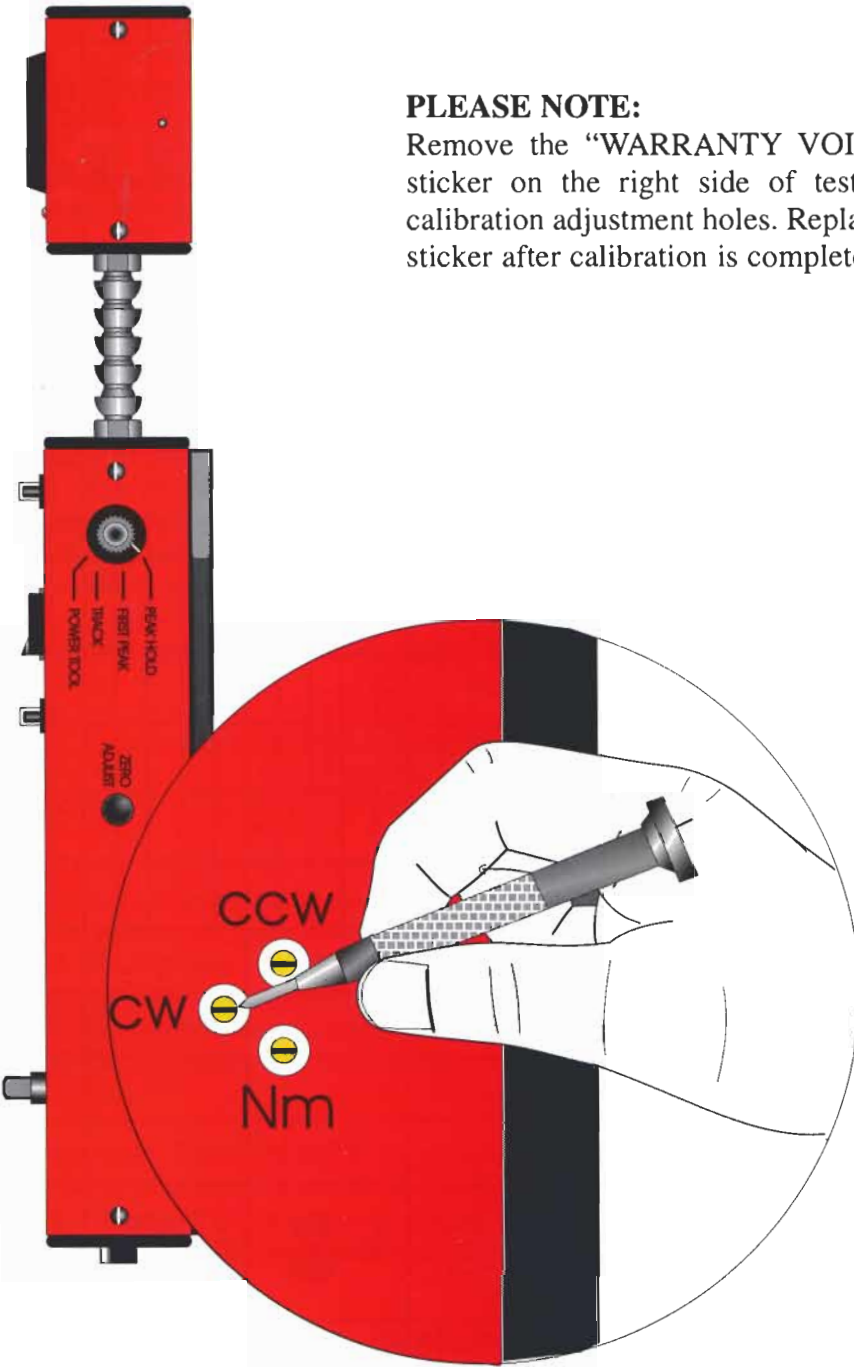

**FIG. 1.5**  
**CALIBRATION ADJUSTMENT HOLE**

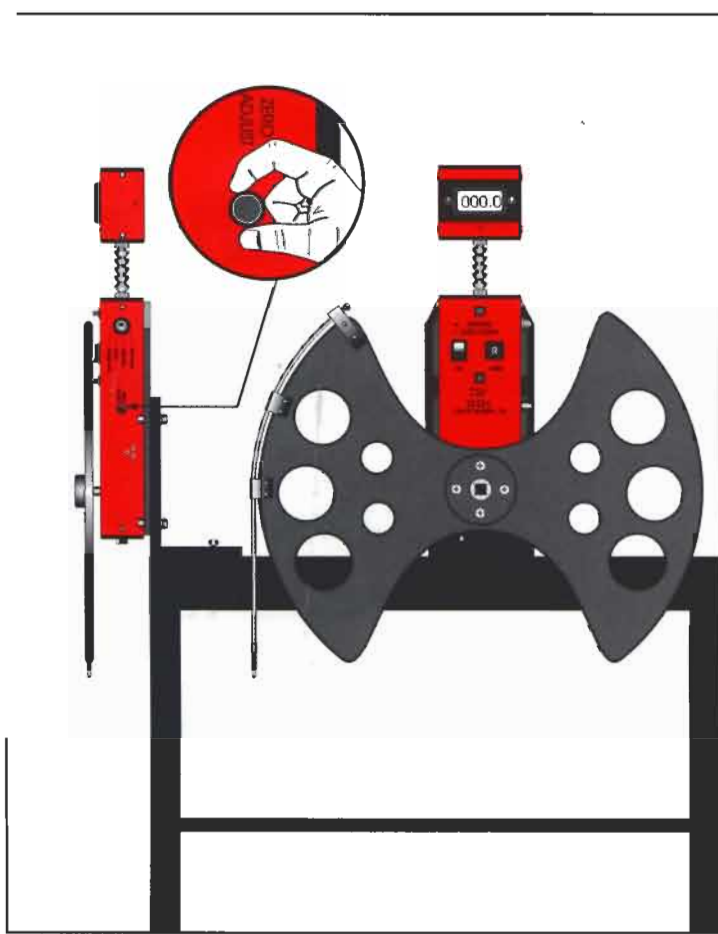

**PLEASE NOTE:**

Make sure the tester is in the “TRACK” mode and the reset mode is in “AUTO CLEAR” when calibrating tester.

FIG. 1.6

ZEROING E.T.T. BEFORE CALIBRATION

**PLEASE NOTE:**

Always use the AC Power cord Adapter when calibrating all E.T.T. models.

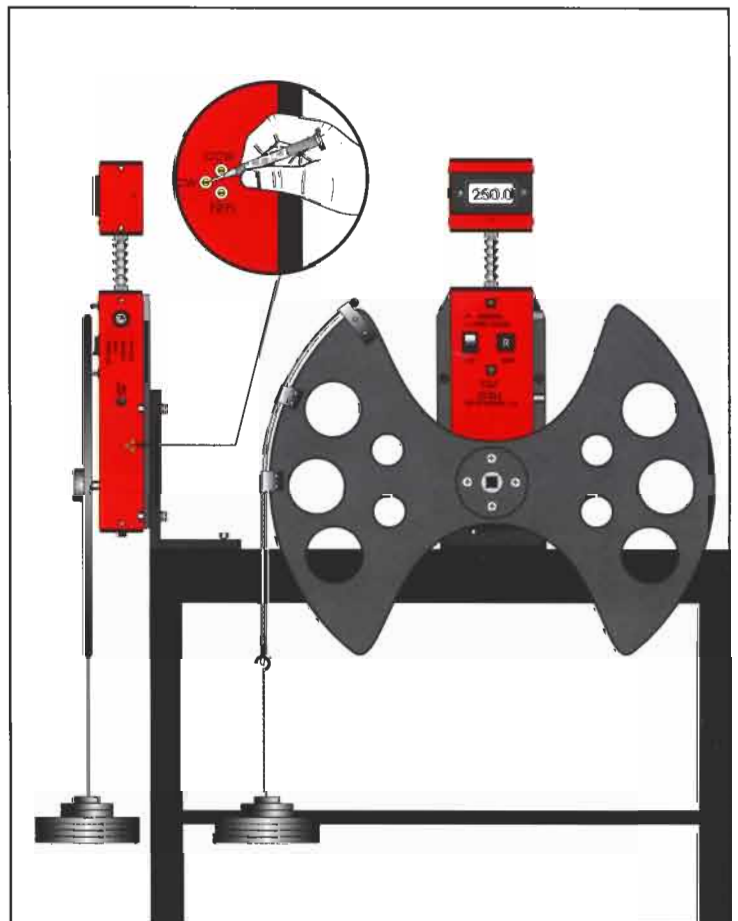

FIG. 1.7

ADJUSTING READING OF E.T.T.  
DURING CALIBRATION

**PLEASE CONSIDER THESE OTHER TORQUE PRODUCTS MANUFACTURED BY CONSOLIDATED DEVICES, INC.**

**ELECTRONIC TORQUE FORCE CALIBRATOR TFC 2000**



**CALIBRATION EQUIPMENT**



**ELECTRONIC TORQUE CALIBRATOR—DIGITEST**



**TORQUE MULTIPLIERS**



**ELECTRONIC TORQUE TESTER—ETT**



**DIAL WRENCHES**



**MICROMETER WRENCHES**



**PRE-SET WRENCHES**



**TRANSDUCERS**



**SCREWDRIVERS**



**PROGRAMMABLE ELECTRONIC TORQUE WRENCH—PET**



**TORKYS**



**COMPUTORQ**



**BEAM TORQUE WRENCHES**



**ELECTRONIC TORQUE LOADERS**



**MECHANICAL TORQUE TESTERS AND LOADERS**



**CDI TORQUE PRODUCTS**